

## Service Trolleys

### Two Tier Service Trolley 400 mm

ITEM # \_\_\_\_\_

MODEL # \_\_\_\_\_

NAME # \_\_\_\_\_

SIS # \_\_\_\_\_

AIA # \_\_\_\_\_



361224 (STR402)

2-tier Service Trolley 400mm

### Short Form Specification

Item No. \_\_\_\_\_

Constructed in 304 AISI stainless steel. Framework in mm25 tubing, completely welded. Seamless, sound-absorbing, shelves with double-folded edges. Shelves are welded to the framework. N. 4 swivelling castors, two with brakes, mm125 in diameter, fitted with plastic bumpers. Shelves size mm400x600. Load capacity: 100 kg, uniformly distributed.

### Main Features

- Framework in 25 mm tubing, completely welded.
- Load capacity of 100 kg uniformly distributed.
- Seamless sound-absorbing shelves with double-folded edges welded to the framework.
- Shelves size 400x600 mm.
- 4 pivoting Ø 125 mm wheels, 2 of which with brakes, fitted with plastic bumpers

### Construction

- Constructed entirely in 304 AISI stainless steel.

APPROVAL: \_\_\_\_\_

**Key Information:**

External dimensions, Width:	495 mm
361224 (STR402)	
External dimensions, Depth:	695 mm
External dimensions, Height:	816 mm
Wheel material:	Zinc plated
Wheel diameter:	Ø 125
Net weight:	15 kg

Front

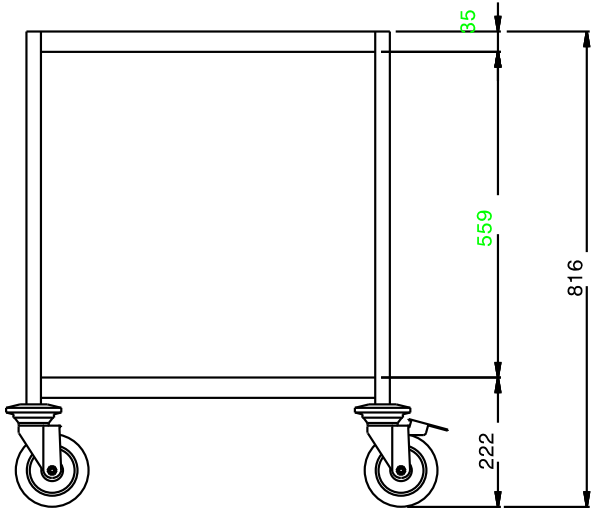

Side

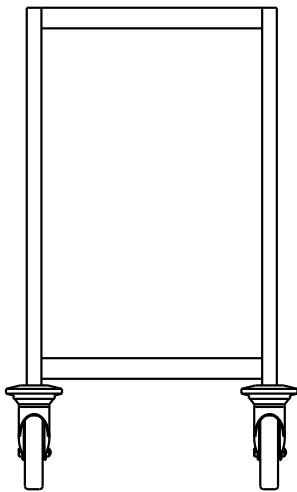

Top

